

X-TRAY®



AXELENT WIRE TRAY

Wire Trays, Fittings, Mountings and Accessories





ABOUT AXELENT

Axelent AB is a family owned company specialized in the production of mesh walls since 1990. During this period, we have developed an integrated concept for product development, production, marketing, sales, service, support and logistics that has turned Axelent into a world leader in the targeted segments. Our products are represented all over the world and we have sales offices in 50 countries.

The Axelent Group consists of Axelent AB, Axelent Safety, Axelent Wire Tray AB, Axelent Engineering AB and Axelent Software. The head office is placed in Hillerstorp in south Sweden.

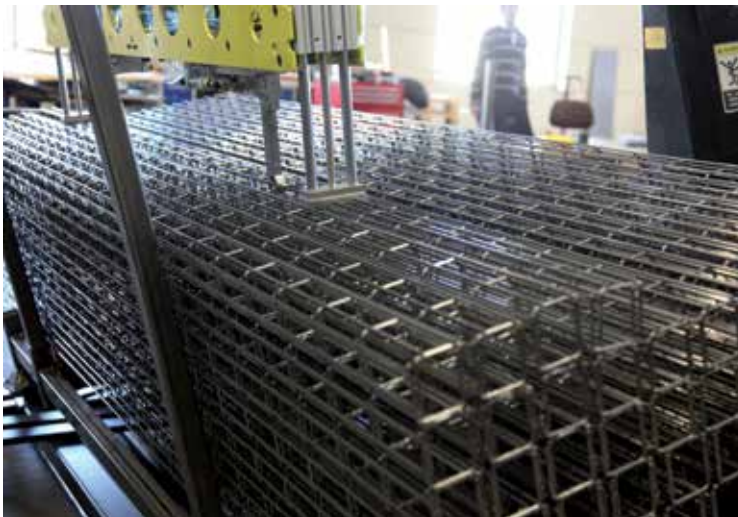

AXELEN WIRE TRAY

Axelen Wire Tray AB develops, manufactures and promotes a cable management system based on wire trays, fittings, mountings and accessories under the brand name X-Tray®. In cooperation with our distributors and end-users we work for the most qualitative, cost effective and functional solutions as possible. We offer a wide basic product programme that meets the requirements for most industries but we also offer applications for unique demands. We can offer a complete solution that includes everything from drawing to the complete product being delivered at site. All our standard products are available from stock, which enables quick deliveries.

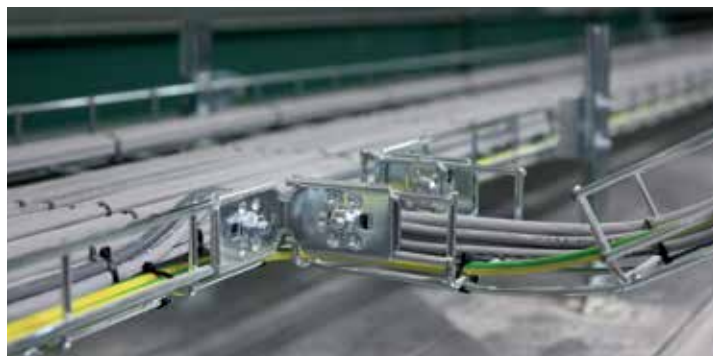

FOOD INDUSTRY



OFF SHORE



MACHINE BUILDING



INFRASTRUCTURE



ENERGY



TELECOM / DATA



Our customers

The majority of our customers are active with the Energy, Infrastructure, Food industry, Machine Building, Off Shore and Telecom/Data industries. We have a long experience within these applications and we know what requirements are to be met.

Our product range is designed to fit to all industries, but we have also special applications adapted to unique demands.

We work worldwide

Through an already established international distributor network, we can not only guarantee precise delivery to any site in the world, but also a wide spectrum of valuable knowledge.

Our support. Your safety

Our vast experience from wire tray, the proximity to production and a local network of suppliers enables us to always give advice and information concerning our products and product solutions.



SnapperWorks

Our own drawing programme SnapperWorks is specially designed for the Axelent Wire Tray products. You will quickly receive an offer, a drawing as well as a bill of material corresponding to your inquiry.



X-TRAY® - The Complete Concept

WHAT'S IN IT FOR YOU?



The Specification

Worker safety, cable safety, vibration safety, electrical and electromagnetic safety. With the quality of the tray, the reliability of the welding and the bolted bonding, you will meet the safety requirements. With the 60-620 mm widths, 60 and 110 mm heights and the zinc-plated, hot dip galvanized, 304L and 316L stainless materials, you will meet the dimension and surface treatment requirements.



The Calculation

You will give the best visual presentation and the quickest offer. Configuration and calculation has never been so easy.



The Supply

X-Tray® is supplied through an international network of experienced distributors in cooperation with Axelent Wire Tray. Whether your projects are small or big, standardized or customized, simple or complex, frequent or punctual.



Total costs

X-Tray® is all about reduction of cost. Less supports and fewer articles will reduce total cost.



The Solution

X-Tray® is about distinct choices and clear instructions. With the X-Tray® technical manual it is easy to find the right solution with the right components and the right assembly.



The Support

You are never alone. The X-Tray® support staff is always there for the extra requirements, the extra applications, the extra adaptations, the extra dimensions and the solutions.



The Job

At the site, the installers will make the planned installation easy with the X-Tray® simplicity. But they will also solve the unplanned problems with the X-Tray® universality.



The Looks

Your customer will look at the installation for the next decades. X-Tray® is a product based on quality in all aspects, this is also shown in the visible look of the product.

The Machine

BUILT TO PERFECTION

Welding wire is nothing new for us in the Axelent Group. We have been welding wire since 1979. We have built our own welding machines since 1999. We know welding.

It was therefore obvious for us that no standard welding machine on the market could meet the requirements for a high quality wire tray. When the wire tray is used in critical applications, the welding quality must never fail. We are therefore proud to inform you about some of the features of the new wire welding machine for X-Tray®.





► The welding points are individually made and individually verified. The X-Tray® is designed to meet the specification – the welding points will not give away during pressure, vibration or corrosion. They will also ensure safe equipotential bonding during the life time of the tray. The welding points are even designed to be the strongest part of the tray.

► The X-Tray® is welded and shaped before the final surface treatment to ensure the perfect finish and the perfect protection.

► The welding machine is highly efficient, more than 10 km per day, but also highly flexible for change in tray length. With a simple reprogramming, the machine will make length between 1500 and 3000 mm. The standard length is 2500 mm, the ideal length for the total handling chain – it fits into trucks, warehouses, containers and, highly appreciated, in work-site elevators.

► Wire ends on the cross wires, are smoothly rounded. There are no sharp edges anywhere in the X-Tray® system. When hands and cables are in motion along the tray, the contact will be gentle.

► All trays are marked with X-Tray®. It will be easy to differentiate between other wire tray and X-Tray®. It is also marked with type of material. The stainless steel is marked with 304L or 316L.

► Built for flexibility. It's possible for us to make wire trays that are not in the standard program, with other lengths, heights or widths. Maximum size before bending is 1000 mm and 3000 mm long. Bending of other heights then standard are possible, even single sided bends.



Designed to be precise

The uniformity of the wire trays is critical, all wire trays must be exactly identical in size, shape and spacing of wires. The new X-Tray® machinery is designed to be extremely precise. The wire trays is a part of a complete system, the X-Tray® system, were the wire trays, the support system and the accessories together form an entity. For this to function, the wire tray must be precisely produced.

Article		Page
X1	Fitting	18
X2	Fitting	18
X3	Angled Fitting	18
X4	Fitting	18
X10	Bracket	18
X10	Mini Bracket	19
X11	Pendant/H	19
X12	Flexible Pendant	19
X13	Side Support	19
X14	Pendant/L	21
X15	Bracket	20
X16	Floor Support	21
X17	Support Hook 120-320	21
X18	Support Hook 420-620	21
X30	Threaded Rod	22
X31	TR Support Hook	22
X33	TR Adaptor	22
X35	TR Distance Nut	22
X36	TR Beam Clamp	22
X50	X-Bar	23
X51	X-Bar Joining Fitting	23

Article		Page
X52	X-Bar Corner Fitting	23
X53	X-Bar Adjustable Foot	23
X54	X-Bar End Cap	23
X60	Radius Limiter	25
X63	Accessories Holder	24
X64	X-Tray L-Divider	24
X65	X-Tray Cover	25
X66	X-Tray Divider	24
X67	X-Tray Divider Clamp	24
X68	Earth Connection Clamp	25
X70	Marking Clip	26
X72	Safety Cap	26

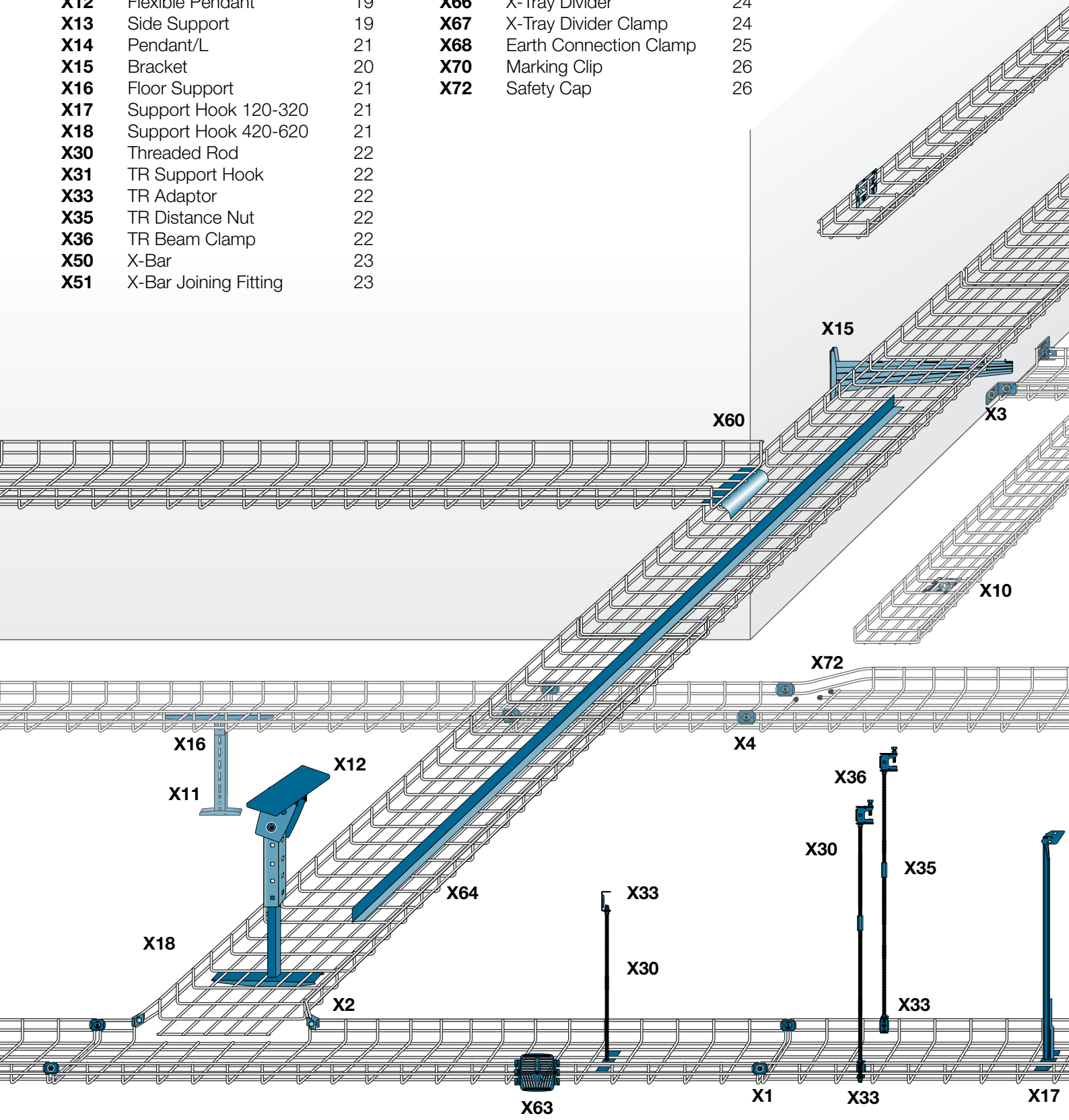

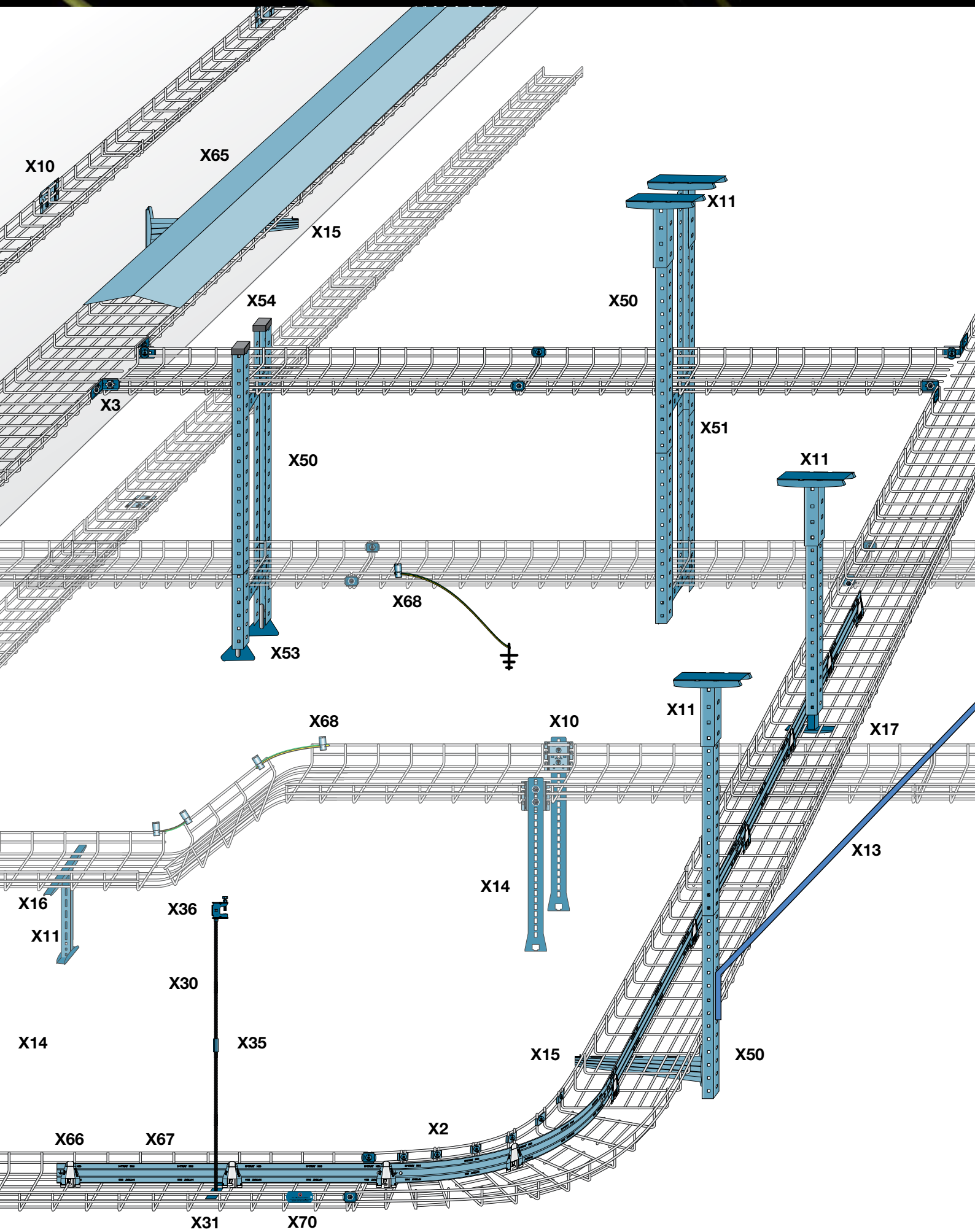

OVERVIEW WIRE TRAY

Standard Trays 60

60x60



120x60

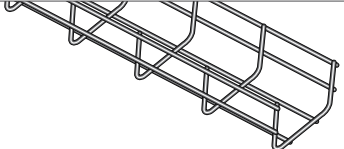

220x60

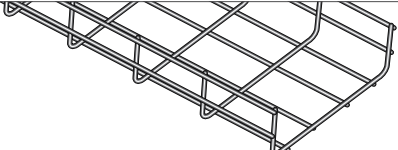

320x60

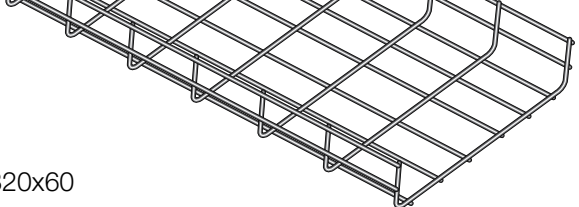

420x60

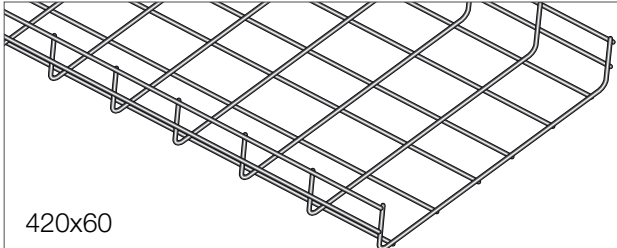

C-Trays

C120x80



C220x120

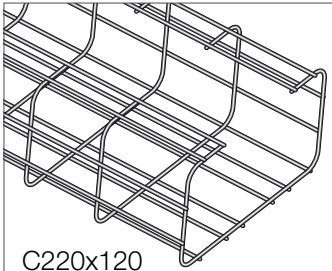

G-Trays

G60x100

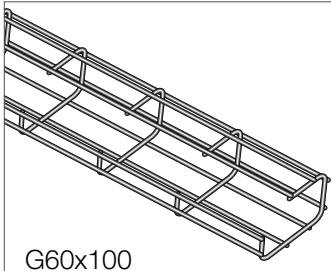

G120x150



Standard Trays 110

120x110

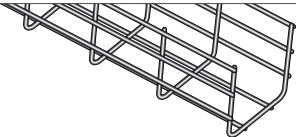

220x110

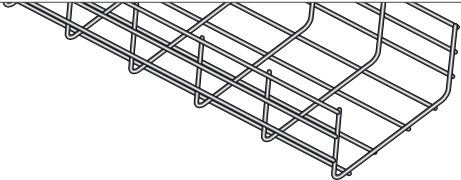

320x110

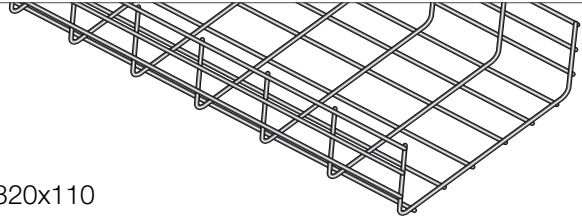

420x110

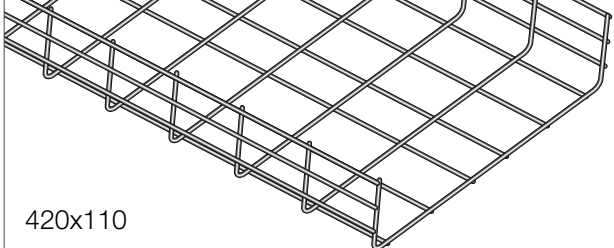

520x110

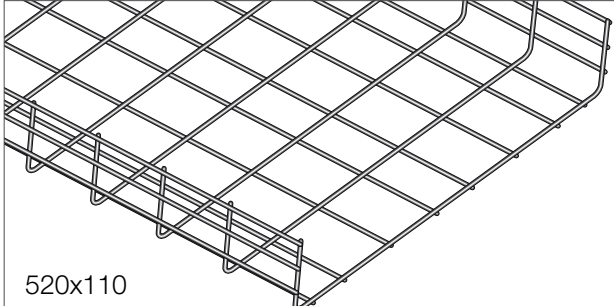

620x110

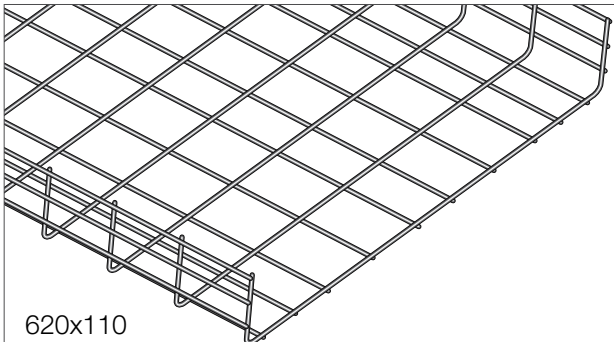

Mini Trays

30x22



40x22



40x32



OVERVIEW ACCESSORIES

Fittings



X1 Fitting

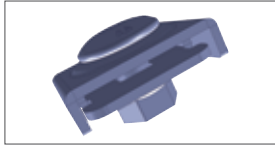

X2 Fitting



X3 Angled Fitting



X4 Fitting

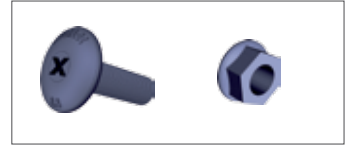

X61 Bolt **X62** Flange Nut

Mountings



X10 Bracket

X10 Mini Bracket

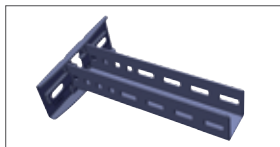

X11 Pendant/H

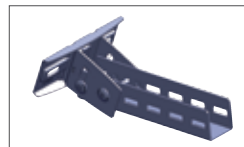

X12 Flexible Pendant

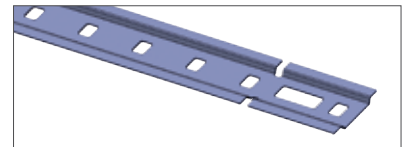

X13 Side Support

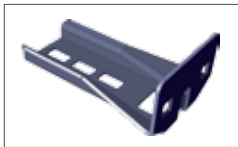

X14 Pendant/L

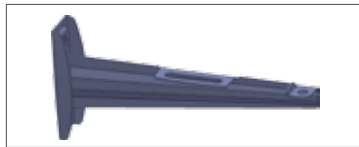

X15 Bracket

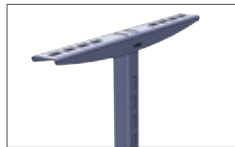

X16 Floor Support



X17 Support Hook
120-320

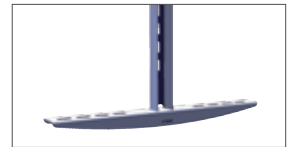

X18 Support Hook
420-620

Threaded Rod

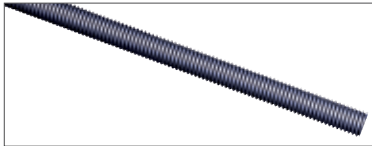

X30 Threaded Rod

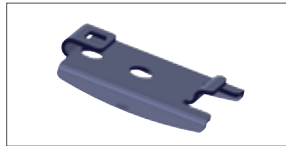

X31 TR Support Hook



X33 TR Adaptor

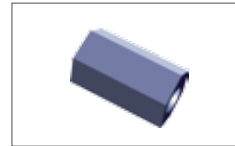

X35 TR Distance Nut



X36 TR Beam Clamp

X-Bar

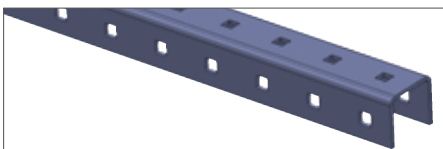

X50 X-Bar

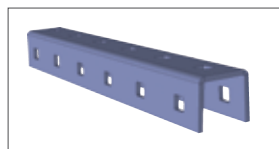

X51 Joining Fitting

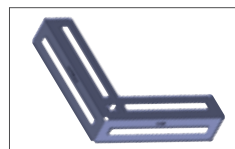

X52 Corner Fitting

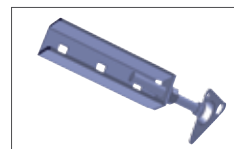

X53 Adjustable Foot



X54 End Cap

Accessories

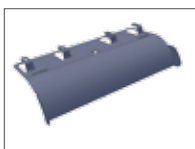

X60 Radius
Limiter

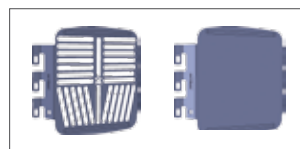

X63 Accessories Holder

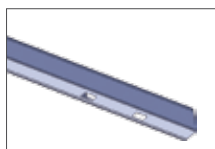

X64 X-Tray
L-Divider



X65 X-Tray
Cover

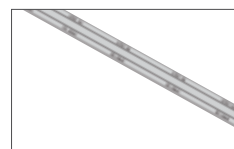

X66 X-Tray
Divider 45 mm

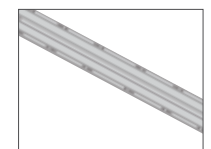

X66 X-Tray
Divider 95 mm



X67 X-Tray
Divider Clamp



X68 Earth
Connection Clamp

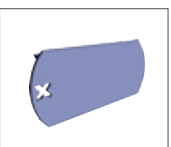

X70
Marking Clip



X72
Safety Cap

Tools

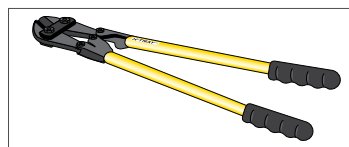

X75 Bolt Cutter

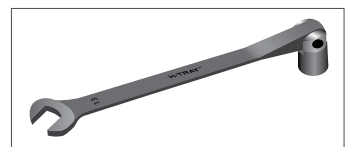

X76 Spanner 13 mm

Accessories are design protected.
Subject to change without prior notice.

TESTED AND APPROVED

The development of the X-Tray® system has been done to meet the demands of IEC 61537 and other appropriate demands.

Cable management - IEC 61537 - Cable tray systems and cable ladder systems

"This International Standard specifies requirements and tests for cable tray systems intended for the support and accommodation of cables and possibly other electrical equipment in electrical and/or communication systems installations."

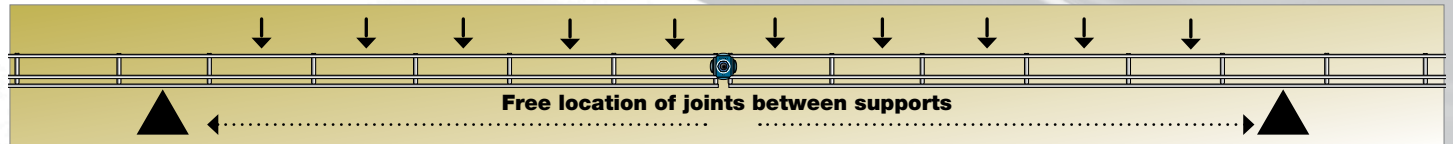

The strength of wire trays and mountings make the installation simple, strong and economical. Bracket spacing can be increased and thus reduce the installation work, with lower costs as a result. The diagrams below show the recommended load at different bracket distances. The joints can be placed anywhere between the brackets.

Choice of trays

Follow these steps for choosing your wire tray.



Environment- demand on surface treatment and/or classification of installation based on standards, given by use, area or specified demands.

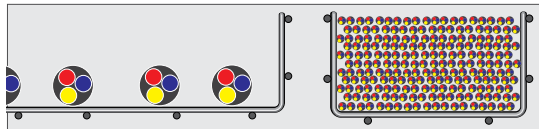

Weight and volume of cables, consider future needs.

Additional weight

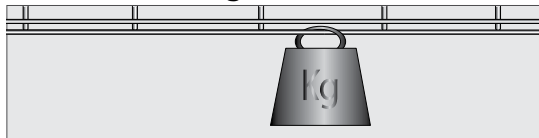

Additional weight from point loads.

Installation

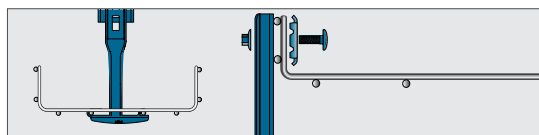

Installations: wall, from ceiling or on floor.

Support distance

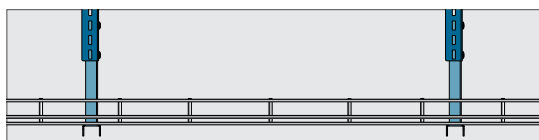

Longer distance between supports - less work and costs.

Equipotential Bonding

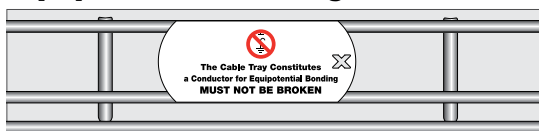

Tested for equipotential bonding.

Loading charts

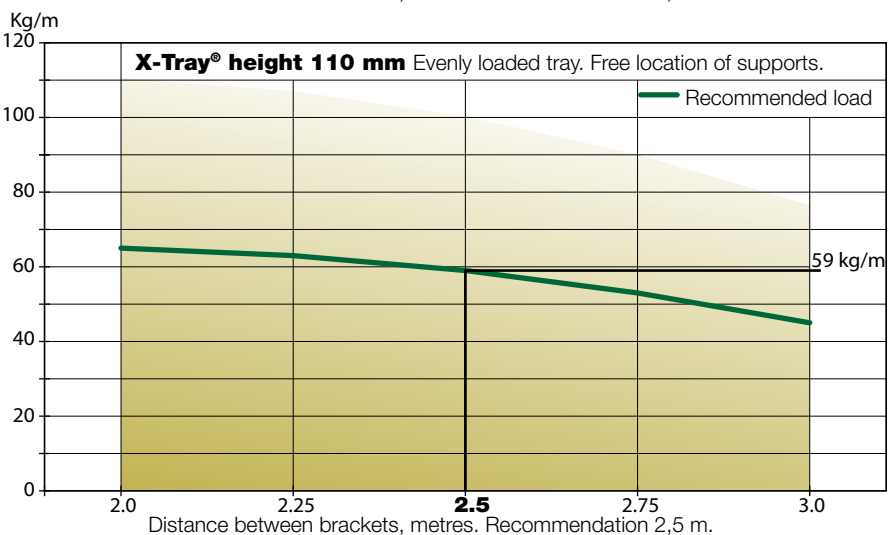
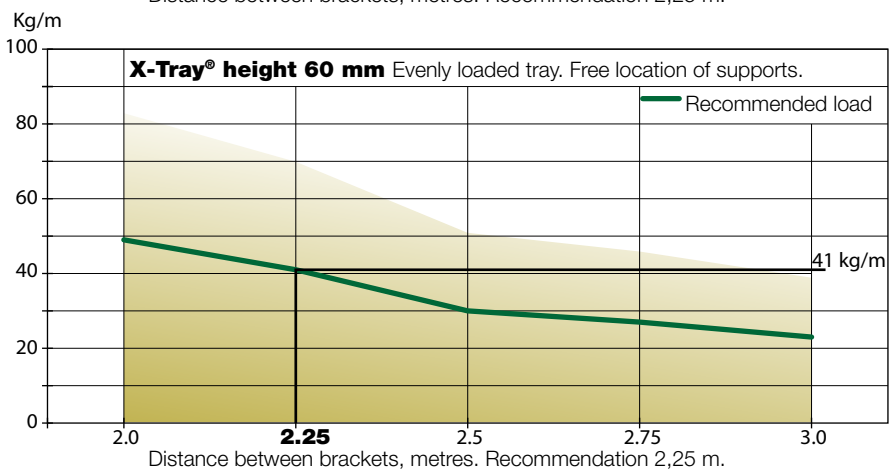
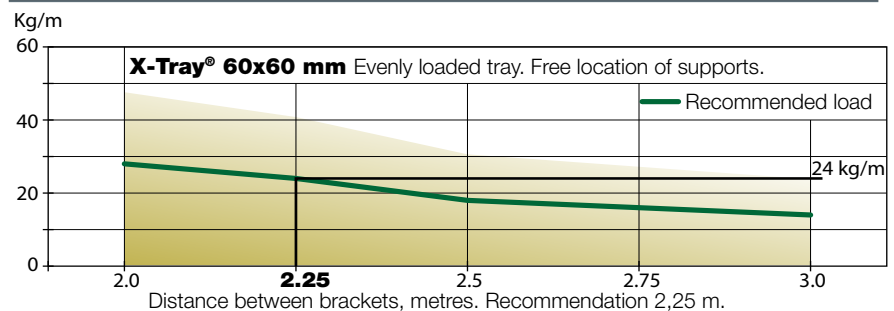

1.7 times these values gives max load per permission according to IEC 61537.

Material

Material is chosen for best welding results and surface treatments. Each batch of material is delivered with specification of the material.

Welding

In production, we perform ongoing tests to check the strength of the welds.

Physical

IEC 61537 have for each component, trays and accessories, methods of testing and a specification of the demands. Added to the general norm will be test on working safety as well as for areas with special demands.

Identification

Every wire tray and accessory is marked with brand and identity. Stainless wire trays are marked on the wires with type of material (304L / 316L).

Electrical

EMC approved by design. Tests are carried out on equipotential bonding, as by DIN VDE 0100 and IEC 61537,11:1.

Surface treatment

X-Ray cable trays have the best surface treatments for all demands;
Zinc Plated (SS-EN ISO 2081:2008, DIN-EN 12329, DIN 50961),
Hot Dip Galvanized (SS-EN ISO 1461:2009, DIN EN ISO 1461),
Zinc/Nickel (SS-EN ISO 11997-1, DIN 50979),
Stainless 304L,
Stainless/Acid Proof 316L.

Vibration

In order to have acceptance in the Off shore sector and also as a base for earthquakes simulation, vibration tests are carried out. Tests are carried out according to Det Norske Veritas D.7.4 class A, with a complete system.

Tests carried out

Loading tests Wire Trays PX10880

Loading tests Accessories PX10880A

Test Equipotential Bonding PX16030

Vibration tests PX17134

UL E350923

NEMA E350923

DNV E11581

Use of test results for certificating in:

Branches:

Telecom/data
Machine building
Off shore
Food industry
Energy
Infrastructure

OEM:

OEM customer has usually demands based on their own markets which might require separate certification and/or tests.

Projects:

We are able to analyze and answer to the demands related to specific projects.

Certificates



Surface treatment recommendations

	Food industry	Off shore	Infra-structure	Energy	Telecom/ data	Machine
Zinc Plated	⚠	⚠	⚠	⚠	✘	✘
Hot Dip Galvanized*	⚠	✘	✘	✘	OK	✘
Stainless 304L	✘	OK	OK	✘	OK	✘
Stainless/Acid Proof 316L	✘	✘	✘	✘	OK	OK

*) Zinc/Nickel (SS-EN ISO 11997-1, DIN 50979) on some parts

✘ Optimal

OK Possible

⚠ Not recommended

Zinc/Nickel

Hot Dip galvanized will on some parts be replaced by Zinc/Nickel (DIN 50979). Zinc/Nickel is electrolytically inorganic corrosion-resistant coatings that meet most requirements for extremely corrosive environment. Zn-Ni containing 12-15% nickel in the layer and provides good corrosion protection even in thin layers. Along with a polished or black passivation can be more than 720 h (according to ISO 9227, NSS) to the base metal corrosion is achieved. Zinc/Nickel can be used together with aluminium.

ISO - Environmental conditions

IEC - Reference, material and finish

X-Tray®

C 1	Indoor heated areas. Outdoor arctic or deserts.	0	None	Zinc plated Black zinc * Hot dipped Zn/Ni Hot dipped Trays 304L 316L
C 2	Indoor unheated areas. Outdoor dry areas with low degree of contamination.	1	Electroplated to a minimum of 5 µm	
C 3	Indoor in humid production areas with low degree of contamination. Coastal areas with low desposition of salt. Mildly contaminated urban and industrial areas.	2	Electroplated to a minimum of 12 µm	
C 4	Chemical plants, indoor swimming pools. Poluted urban and industrial areas. Coastal areas with low desposition of salt.	3	Pregalvanised to grade 275 according to EN 10327 and EN 10326	
C 5	Industrial with high degree of pollution and high humidity. Coastal and offshore areas with high desposition of salt.	4	Pregalvanised to grade 350 according to EN 10327 and EN 10326	
		5	Post-galvanised to a zinc mean coating thickness (minimum) of 45 µm according to ISO 1461 for zinc thickness only	
		6	Post-galvanised to a zinc mean coating thickness (minimum) of 55 µm according to ISO 1461 for zinc thickness only	
		7	Post-galvanised to a zinc mean coating thickness (minimum) of 70 µm according to ISO 1461 for zinc thickness only	
		8	Post-galvanised to a zinc mean coating thickness (minimum) of 85 µm according to ISO 1461 for zinc thickness only (high silicon steel)	
		9A	Stainless steel manufactured to ASTM: A240/A-95A designation S30400 or EN 10088 grade 1-4301 without post treatment	
		9B	Stainless steel manufactured to ASTM: A240/A-95A designation S31603 or EN 10088 grade 1-4404 without post treatment	* Only by order
		9C	Stainless steel manufactured to ASTM: A240/A-95A designation S30400 or EN 10088 grade 1-4301 without post treatment	
		9D	Stainless steel manufactured to ASTM: A240/A-95A designation S31603 or EN 10088 grade 1-4301 without post treatment	

All dimensions in mm. All measurements are on the outside of the wire tray

X-TRAY® MINI

Article	Art.no.	Pack
X-Tray Mini 30x22		
Zinc Plated	1152	1
Hot Dip Galvanized	1252	1
Stainless 316L	1352	1
Stainless 304L	1452	1
X-Tray Mini 40x22		
Zinc Plated	1153	1
Hot Dip Galvanized	1253	1
Stainless 316L	1353	1
Stainless 304L	1453	1
X-Tray Mini 40x32		
Zinc Plated	1154	1
Hot Dip Galvanized	1254	1
Stainless 316L	1354	1
Stainless 304L	1454	1

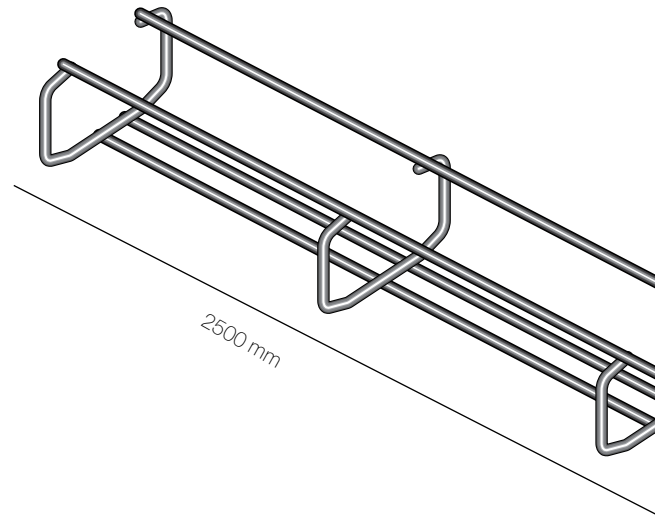
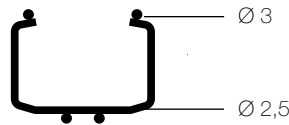
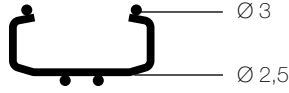
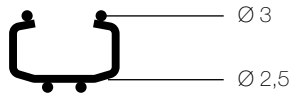

X-Tray® Mini

Axellent Wire Tray have under the brand X-Tray® launched a complete system for cable management. Now we are launching the X-Tray Mini. Mini trays in the measurements, 30x22 mm, 40x22 mm & 40x32mm.

Smarter solutions. Faster installations

Forget about plastic tubes and special sheet-metal duct solutions. X-Tray Mini has already in the idea-phase been thinking installation and logistics. Our standard tray is all you will need. Cut and bend at site to find the best solution. No complicated fittings. X-Tray Mini is engineered to provide you a fast and simple installation, can be mounted or welded directly onto machine parts for example.

All dimensions in mm. All measurements are on the outside of the wire tray

X-TRAY® 60

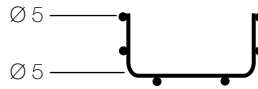
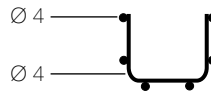
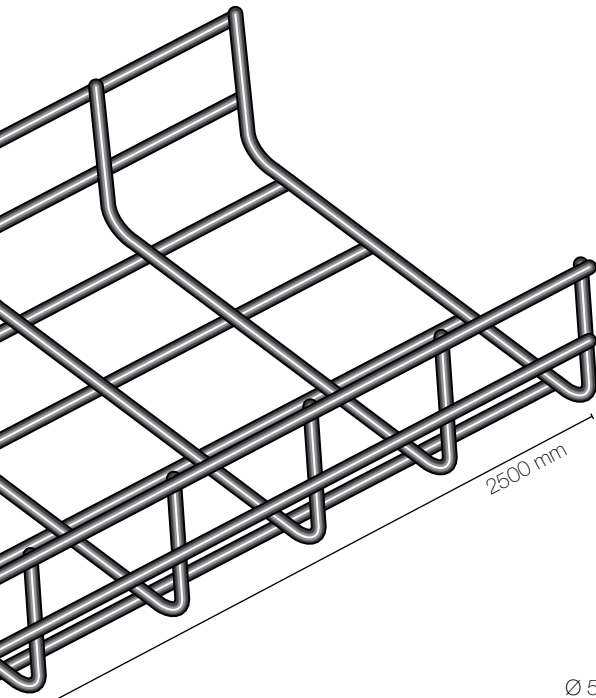

Article **Art.no.** **Pack**

X-Tray 60x60		
Zinc Plated	0101	1
Hot Dip Galvanized	0201	1
Stainless 316L	0301	1
Stainless 304L	0401	1

X-Tray 120x60		
Zinc Plated	0111	1
Hot Dip Galvanized	0211	1
Stainless 316L	0311	1
Stainless 304L	0411	1

X-Tray 220x60		
Zinc Plated	0121	1
Hot Dip Galvanized	0221	1
Stainless 316L	0321	1
Stainless 304L	0421	1

X-Tray 320x60		
Zinc Plated	0131	1
Hot Dip Galvanized	0231	1
Stainless 316L	0331	1
Stainless 304L	0431	1

X-Tray 420x60		
Zinc Plated	0141	1
Hot Dip Galvanized	0241	1
Stainless 316L	0341	1
Stainless 304L	0441	1

X-TRAY® G

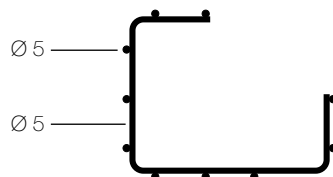
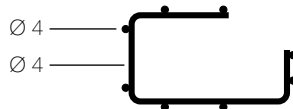
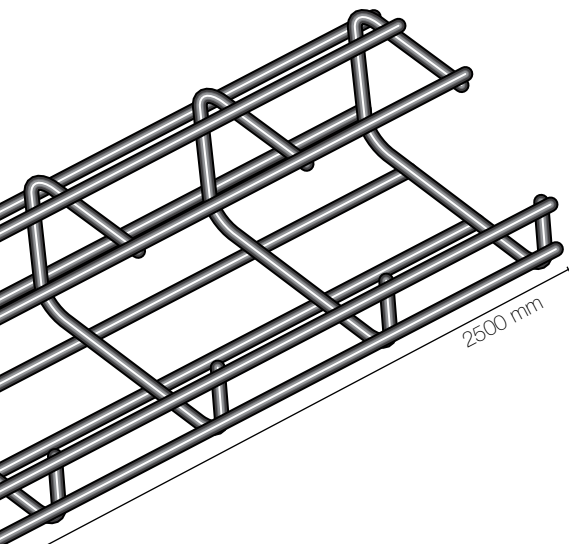

Article **Art.no.** **Pack**

X-Tray G60x100		
Zinc Plated	1121	1
Hot Dip Galvanized	1221	1
Stainless 316L	1321	1
Stainless 304L	1421	1

X-Tray G120x150		
Zinc Plated	1122	1
Hot Dip Galvanized	1222	1
Stainless 316L	1322	1
Stainless 304L	1422	1

Built for flexibility. It's possible for us to make wire trays with other lengths, heights or widths or shapes. For more info www.axelentwt.com.

All dimensions in mm. All measurements are on the outside of the wire tray

X-TRAY® 110

Article	Art.no.	Pack
X-Tray 120x110		
Zinc Plated	0112	1
Hot Dip Galvanized	0212	1
Stainless 316L	0312	1
Stainless 304L	0412	1
X-Tray 220x110		
Zinc Plated	0122	1
Hot Dip Galvanized	0222	1
Stainless 316L	0322	1
Stainless 304L	0422	1
X-Tray 320x110		
Zinc Plated	0132	1
Hot Dip Galvanized	0232	1
Stainless 316L	0332	1
Stainless 304L	0432	1
X-Tray 420x110		
Zinc Plated	0142	1
Hot Dip Galvanized	0242	1
Stainless 316L	0342	1
Stainless 304L	0442	1
X-Tray 520x110		
Zinc Plated	0152	1
Hot Dip Galvanized	0252	1
Stainless 316L	0352	1
Stainless 304L	0452	1
X-Tray 620x110		
Zinc Plated	0162	1
Hot Dip Galvanized	0262	1
Stainless 316L	0362	1
Stainless 304L	0462	1

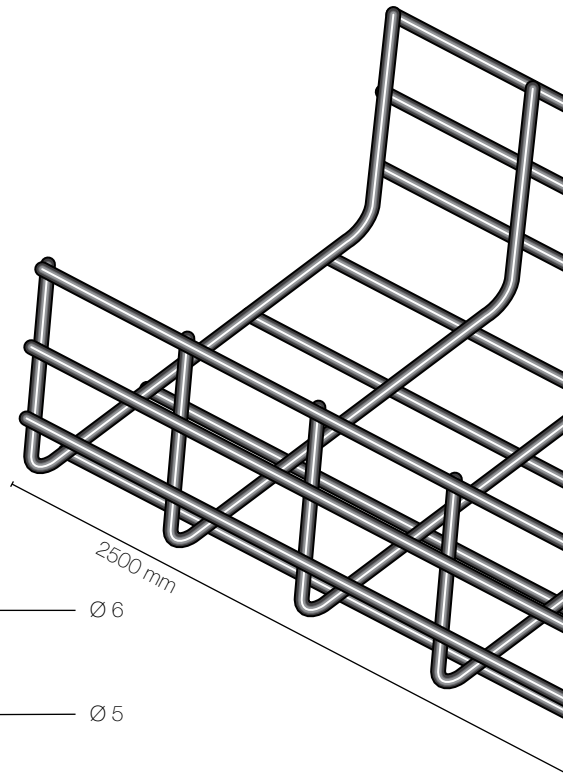
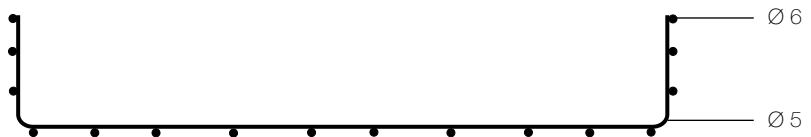
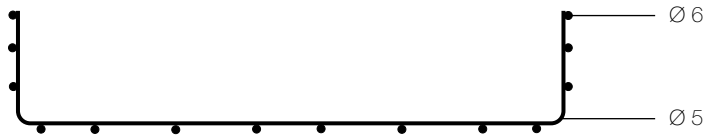
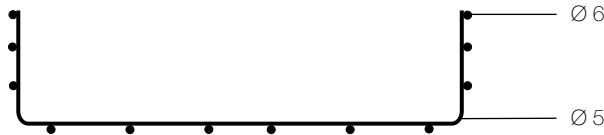
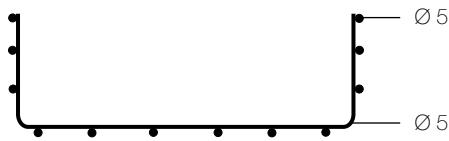
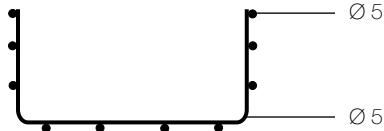
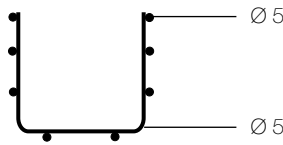

Article	Art.no.	Pack
X-Tray C120x80		
Zinc Plated	1111	1
Hot Dip Galvanized	1211	1
Stainless 316L	1311	1
Stainless 304L	1411	1
X-Tray C220x120		
Zinc Plated	1112	1
Hot Dip Galvanized	1212	1
Stainless 316L	1312	1
Stainless 304L	1412	1

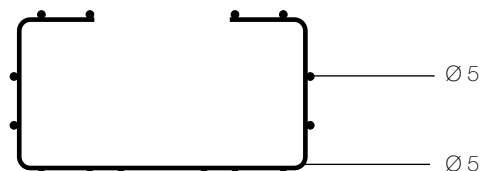
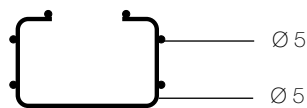

X-TRAY® C

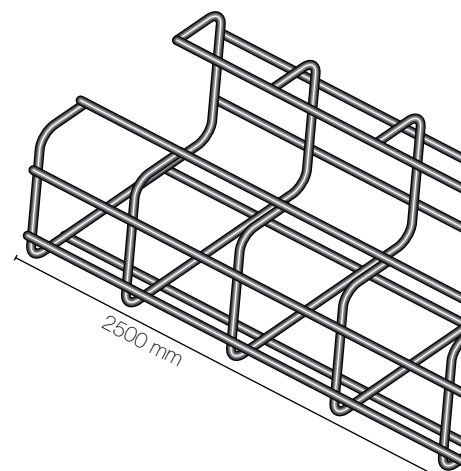

FITTINGS

All dimensions in mm. For more assembly instructions please visit www.axelentwt.com

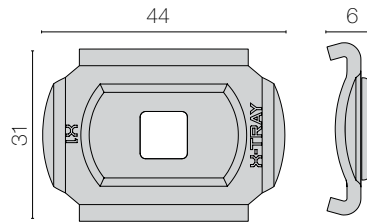
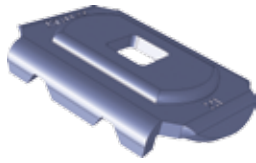

Article	Art.no.	Pack
---------	---------	------

X1 Fitting

Zinc Plated	2101	1
Hot Dip Galvanized*	2201	1
Stainless 316L	2301	1

40 320

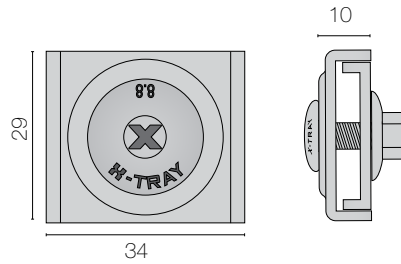
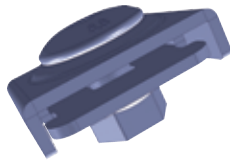

X2 Fitting

Zinc Plated	2102	1
Hot Dip Galvanized*	2202	1
Stainless 316L	2302	1

Delivered with bolt and nut.

40 160

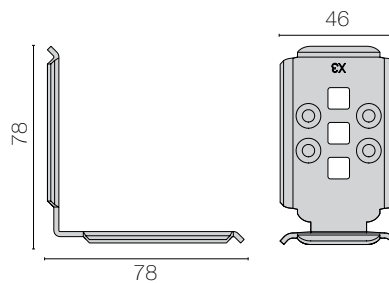
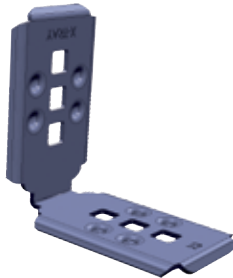

X3 Angled Fitting

Zinc Plated	2103	1
Hot Dip Galvanized*	2203	1
Stainless 316L	2303	1

For T-junctions and mountings.

10 60

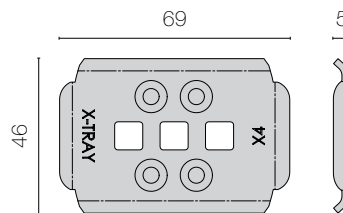

X4 Fitting

Zinc Plated	2104	1
Hot Dip Galvanized*	2204	1
Stainless 316L	2304	1

40 160

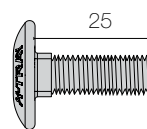

X61 Bolt M8x25, pack of 40

Zinc Plated	2161	1
Hot Dip Galvanized*	2261	1
Stainless 316L	2361	1

10

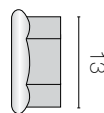

X62 Flange Nut M8, pack of 40

Zinc Plated	2162	1
Hot Dip Galvanized*	2262	1
Stainless 316L	2362	1

10

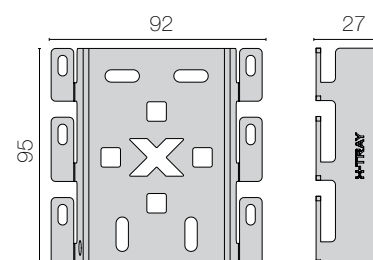

X10 Bracket

Zinc Plated	2110-1	1
Hot Dip Galvanized	2210-1	1
Stainless 316L	2310-1	1

Brackets for wall and pendant mounting.
M8 bolts for walls and X61/X62 bolt and nut for pendants.

12 60

*) Zinc/Nickel, DIN50979, see page 14

All dimensions in mm. For more assembly instructions please visit www.axelentwt.com

MOUNTINGS

Article	Art.no.	Pack
---------	---------	------

X10 Mini Bracket

Zinc Plated	2110-2	1
Hot Dip Galvanized	2210-2	1
Stainless 316L	2310-2	1

Brackets for wall and pendant mounting. M8 bolts for walls and X61/X62 bolt and nut for pendants.

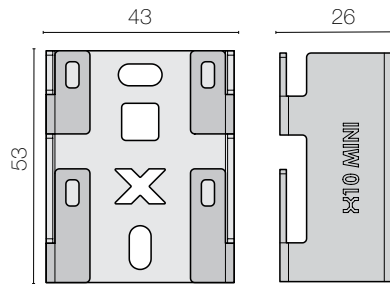
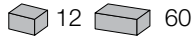

X11 Pendant/H 240

Zinc Plated	2111-240	1
Hot Dip Galvanized*	2211-240	1
Stainless 316L	2311-240	1

For heavy installations. Mounted with M8/M10 bolt. For extension, use X50 X-Bar.

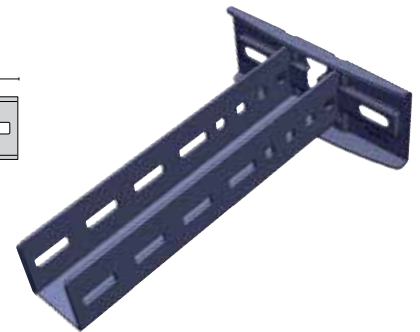
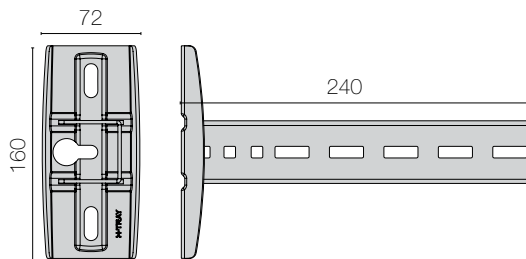

X11 Pendant/H 480

Zinc Plated	2111-480	1
Hot Dip Galvanized*	2211-480	1
Stainless 316L	2311-480	1

For heavy installations. Mounted with M8/M10 bolt. For extension, use X50 X-Bar.

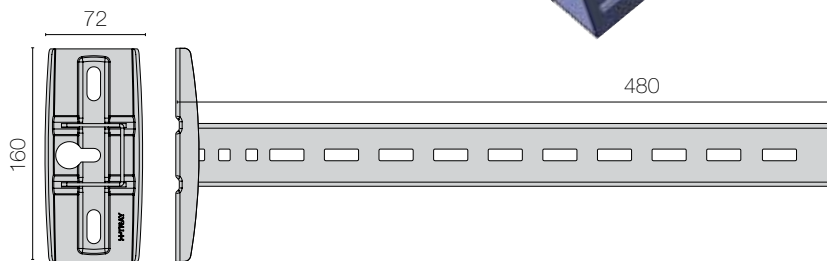

X12 Flexible Pendant 240

Zinc Plated	2112-240	1
Hot Dip Galvanized*	2212-240	1
Stainless 316L	2312-240	1

Ceiling fitting adjustable 15°. Mounted with M8/M10 bolt. For extension, use X50 X-Bar.

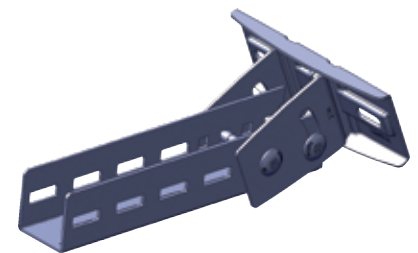
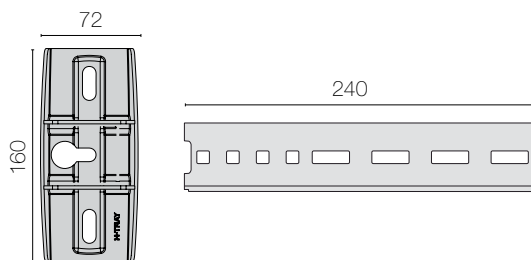

X12 Flexible Pendant 480

Zinc Plated	2112-480	1
Hot Dip Galvanized*	2212-480	1
Stainless 316L	2312-480	1

Ceiling Fitting adjustable 15°. Mounted with M8/M10 bolt. For extension, use X50 X-Bar.

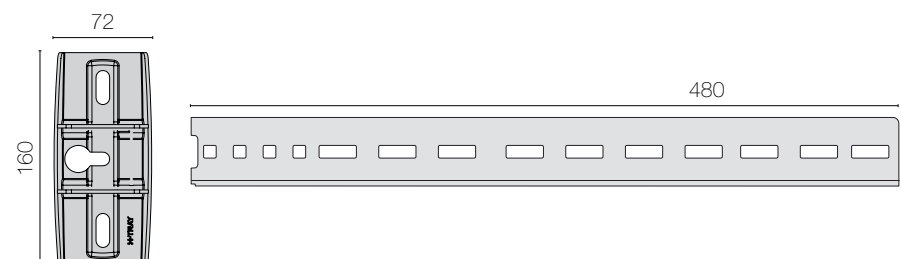

X13 Side Support

Zinc Plated	2113	1
Hot Dip Galvanized	2213	1
Stainless 316L	2313	1

Increases the stability of pendants.

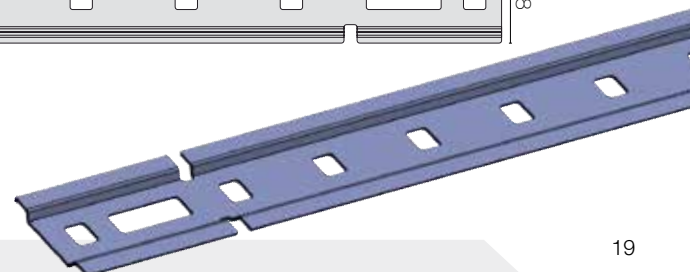
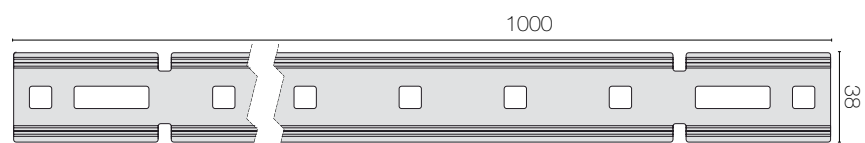

*) Zinc/Nickel, DIN50979, see page 14

MOUNTINGS

All dimensions in mm. For more assembly instructions please visit www.axelentwt.com

Article Art.no. Pack

X15 Bracket 60-120

Zinc Plated	2115-120	1
Hot Dip Galvanized	2215-120	1
Stainless 316L	2315-120	1

Bracket for wall and pendant mounting. M8/M10 bolt for wall and X61/X62 bolt and nut for pendants.

 10

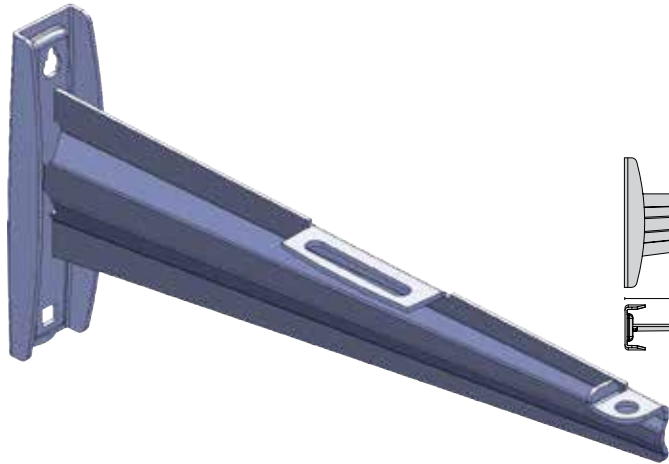
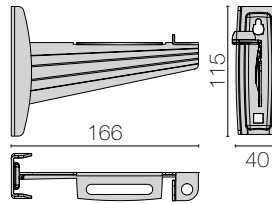

X15 Bracket 220

Zinc Plated	2115-220	1
Hot Dip Galvanized	2215-220	1
Stainless 316L	2315-220	1

Bracket for wall and pendant mounting. M8/M10 bolt for wall and X61/X62 bolt and nut for pendants.

 10

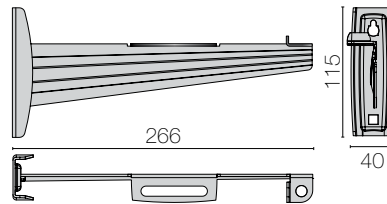

X15 Bracket 320

Zinc Plated	2115-320	1
Hot Dip Galvanized	2215-320	1
Stainless 316L	2315-320	1

Bracket for wall and pendant mounting. M8/M10 bolt for wall and X61/X62 bolt and nut for pendants.

 10

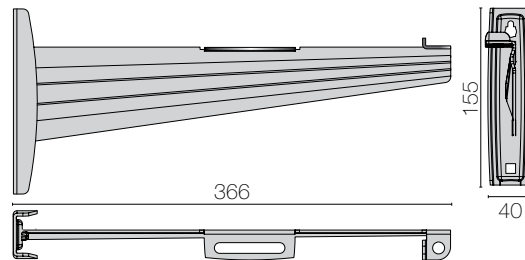

X15 Bracket 420

Zinc Plated	2115-420	1
Hot Dip Galvanized	2215-420	1
Stainless 316L	2315-420	1

Bracket for wall and pendant mounting. M8/M10 bolt for wall and X61/X62 bolt and nut for pendants.

 10

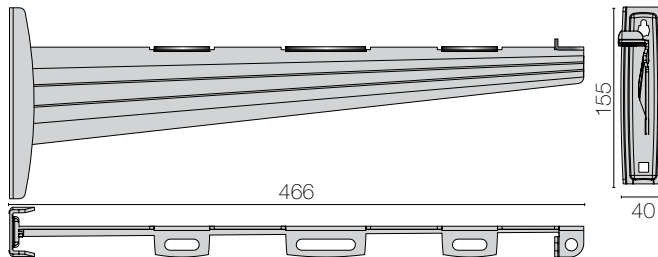

X15 Bracket 520

Zinc Plated	2115-520	1
Hot Dip Galvanized	2215-520	1
Stainless 316L	2315-520	1

Bracket for wall and pendant mounting. M8/M10 bolt for wall and X61/X62 bolt and nut for pendants.

 6

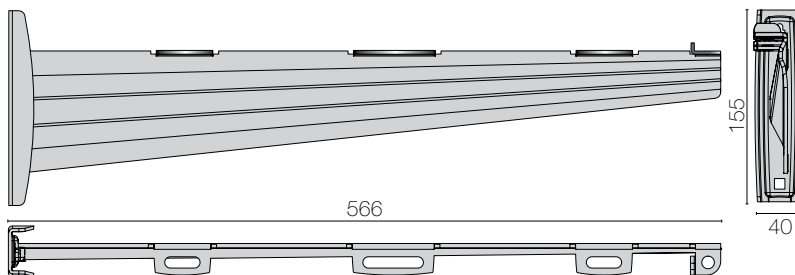

X15 Bracket 620

Zinc Plated	2115-620	1
Hot Dip Galvanized	2215-620	1
Stainless 316L	2315-620	1

Bracket for wall and pendant mounting. M8/M10 bolt for wall and X61/X62 bolt and nut for pendants.

 6

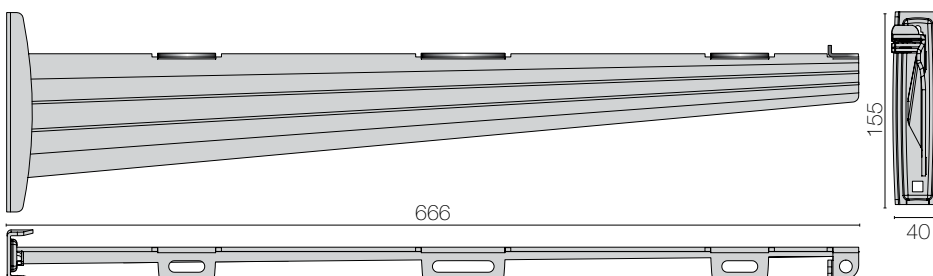

All dimensions in mm. For more assembly instructions please visit www.axelentwt.com

MOUNTINGS

Article	Art.no.	Pack
X14 Pendant/L 100		
Zinc Plated	2114-100	1
Hot Dip Galvanized	2214-100	1
Stainless 316L	2314-100	1
Pendant for <u>light</u> installations.		
		 16

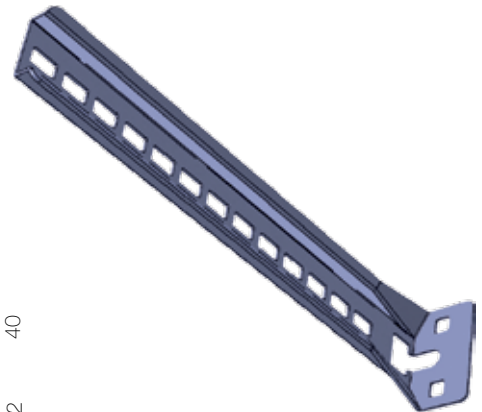
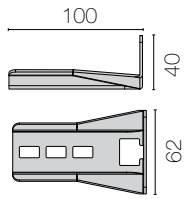

X14 Pendant/L 280		
Zinc Plated	2114-280	1
Hot Dip Galvanized	2214-280	1
Stainless 316L	2314-280	1
Pendant for <u>light</u> installations.		
		 16

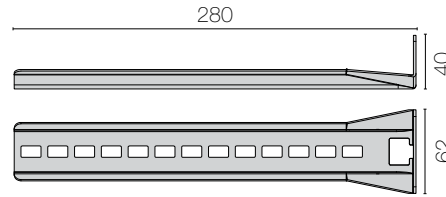

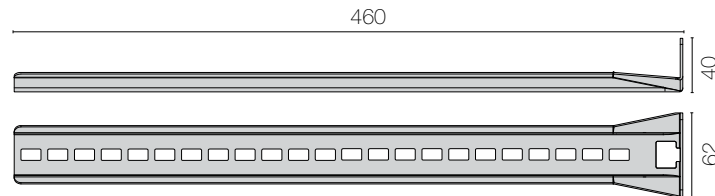

X14 Pendant/L 460		
Zinc Plated	2114-460	1
Hot Dip Galvanized	2214-460	1
Stainless 316L	2314-460	1
Pendant for <u>light</u> installations.		
		 16

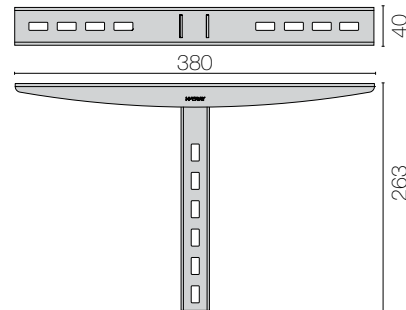

X16 Floor Support		
Zinc Plated	2116	1
Hot Dip Galvanized	2216	1
Stainless 316L	2316	1
 8		



X17 Support Hook 120-320		
Zinc Plated	2117	1
Hot Dip Galvanized	2217	1
Stainless 316L	2317	1
		 8  16

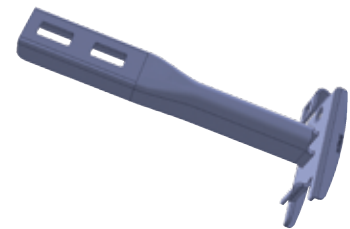
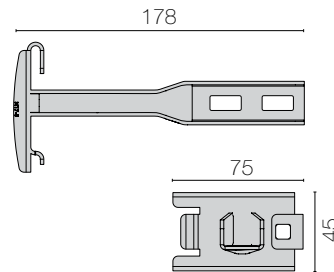

X18 Support Hook 420-620		
Zinc Plated	2118	1
Hot Dip Galvanized	2218	1
Stainless 316L	2318	1
Support hook for X-Tray 420-620 mm.		
		 8

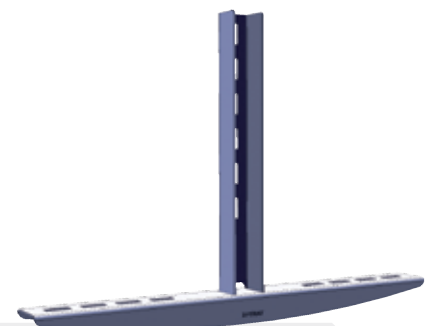
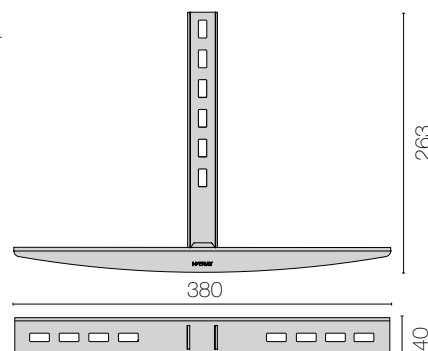

THREADED ROD

All dimensions in mm. For more assembly instructions please visit www.axelentwt.com

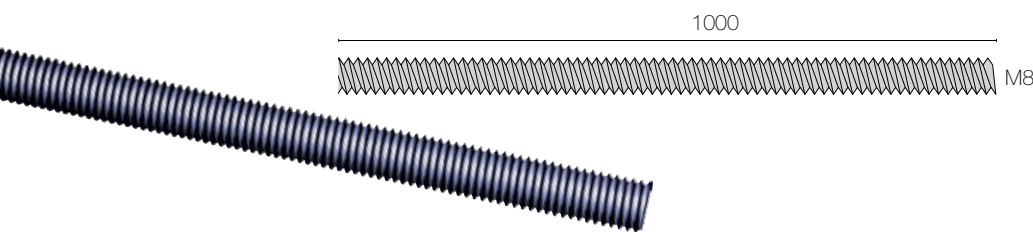

Article	Art.no.	Pack
---------	---------	------

X30 Threaded Rod M8x1000

Zinc Plated	2130	1
Hot Dip Galvanized*	2230	1
 10		

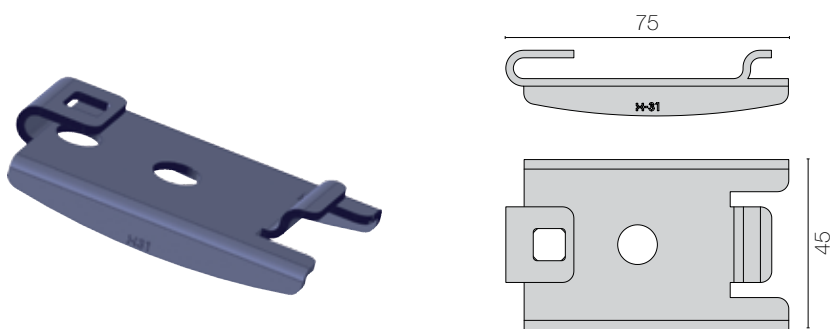

X31 TR Support Hook

Zinc Plated	2131	1
Hot Dip Galvanized*	2231	1
For X-Tray 120-220 mm.		
 10	 60	

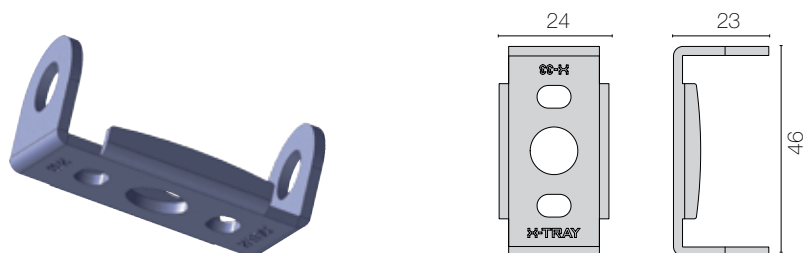

X33 TR Adaptor

Zinc Plated	2133	1
Hot Dip Galvanized*	2233	1
For mounting of Threaded Rod.		
 10	 100	

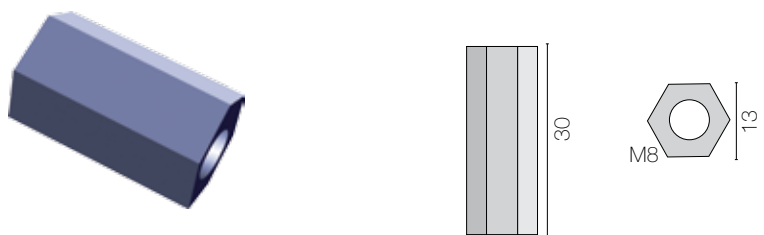

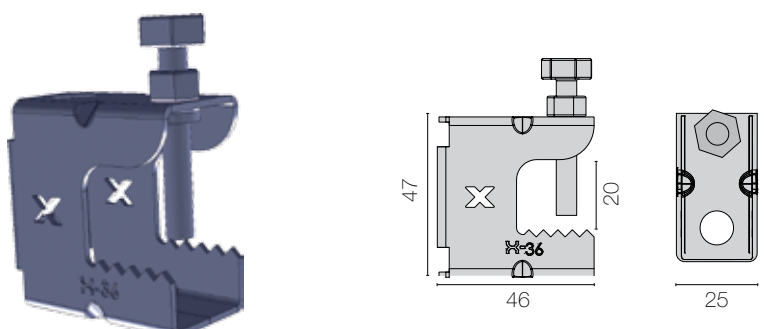

X35 TR Distance Nut M8, pack of 10

Zinc Plated	2135	1
Hot Dip Galvanized*	2235	1
To join Threaded Rods.		
 10		



X36 TR Beam Clamp

Hot Dip Galvanized*	2236	1
For mounting of Threaded Rod or X-Tray.		
 10	 40	

*) Zinc/Nickel, DIN50979, see page 14

All dimensions in mm. For more assembly instructions please visit www.axelentwt.com

X-BAR

Article	Art.no.	Pack
X50 X-Bar 400-2480 mm		
Zinc Plated	2150-400	1
Hot Dip Galvanized*	2250-400	1
Stainless 316L	2350-400	1
Zinc Plated	2150-600	1
Hot Dip Galvanized*	2250-600	1
Stainless 316L	2350-600	1
Zinc Plated	2150-800	1
Hot Dip Galvanized*	2250-800	1
Stainless 316L	2350-800	1
Zinc Plated	2150-1000	1
Hot Dip Galvanized*	2250-1000	1
Stainless 316L	2350-1000	1
Zinc Plated	2150-1920	1
Zinc Plated	2150-2120	1
Zinc Plated	2150-2480	1

Used as extension to X11 / X12 Pendants.
Or separately to build cable channelling structures.

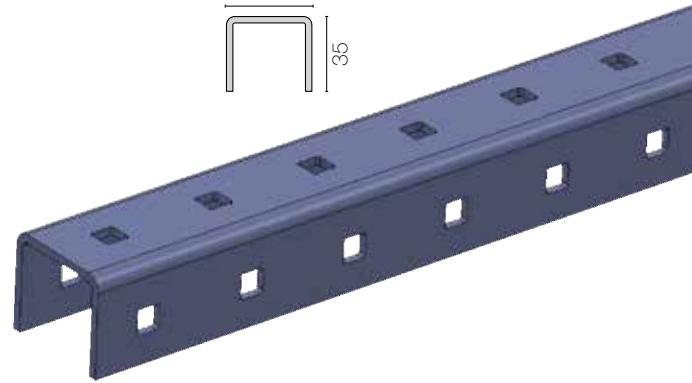
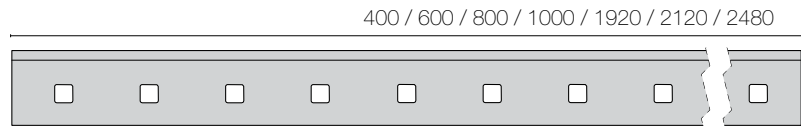

X51 X-Bar Joining Fitting		
Zinc Plated	2151	1
Hot Dip Galvanized*	2251	1
Stainless 316L	2351	1

To join X-bars.

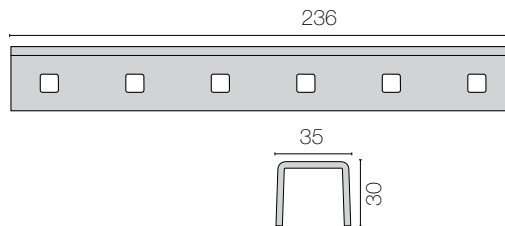

X52 X-Bar Corner Fitting		
Zinc Plated	2152	1
Hot Dip Galvanized*	2252	1
Stainless 316L	2352	1

To mount and join X-bars.

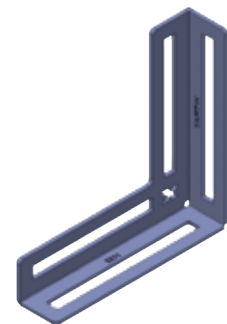
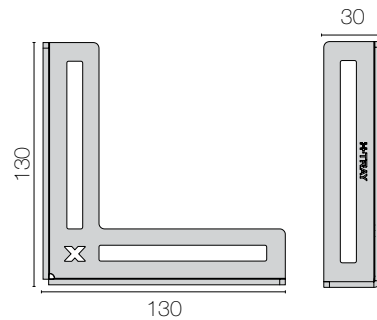

X53 X-Bar Adjustable Foot		
Zinc Plated	2153	1
Hot Dip Galvanized*	2253	1

Adjustable Foot to compensate for uneven floors.

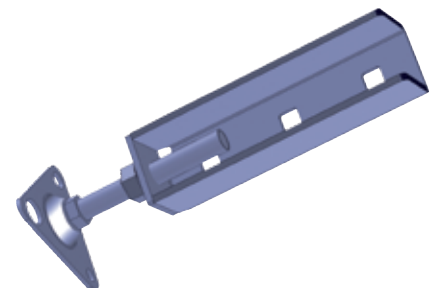
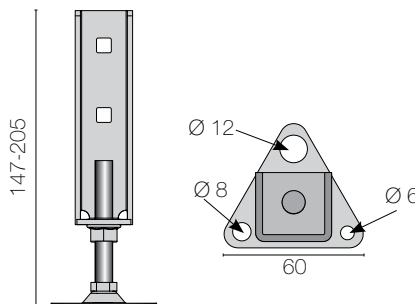

X54 X-Bar End Cap		
Plastic, black	2554	1

Safety Cap for X-Bar ends.

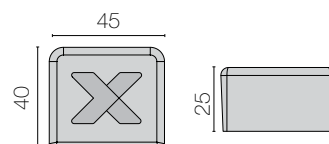

*) Zinc/Nickel, DIN50979, see page 14

All dimensions in mm

ACCESSORIES

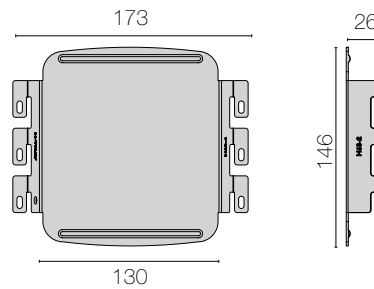
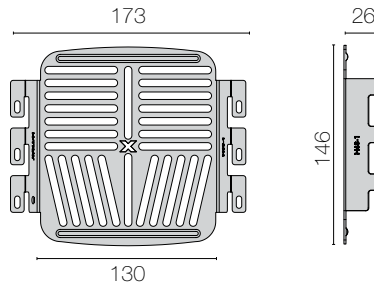
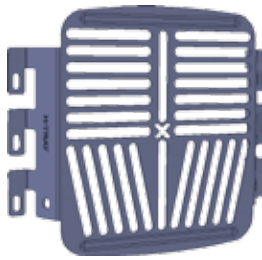

Article	Art.no.	Pack
---------	---------	------

X63 Accessories Holder

Zinc Plated	2163-1	1
Hot Dip Galvanized	2263-1	1
Stainless 316L	2363-1	1

Accessories Holder with holes. For any X-Tray.



X63 Accessories Holder without Holes

Zinc Plated	2163-2	1
Hot Dip Galvanized	2263-2	1
Stainless 316L	2363-2	1

Accessories Holder without holes. For any X-Tray.

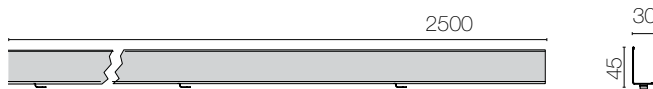
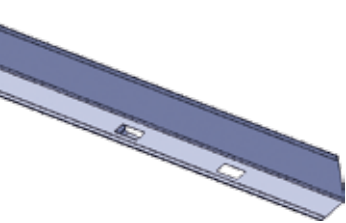

X64 X-Tray L-Divider 45 mm

Pre Galvanized	2264-45	1
Stainless 316L	2364-45	1

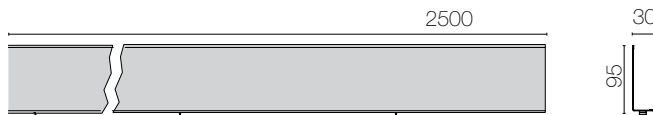
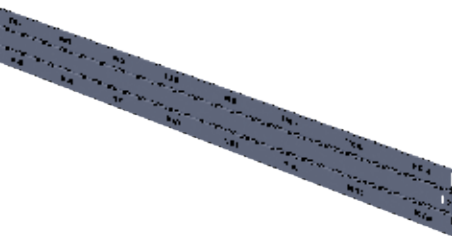

X64 X-Tray L-Divider 95 mm

Pre Galvanized	2264-95	1
Stainless 316L	2364-95	1

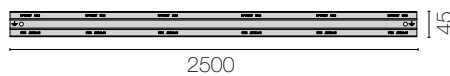

X66 X-Tray Divider 45 mm

Pre-Galv	2266-45	1
Stainless 316L	2366-45	1

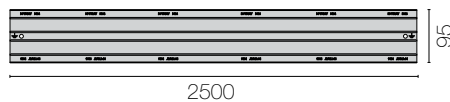

X66 X-Tray Divider 95 mm

Pre-Galv	2266-95	1
Stainless 316L	2366-95	1

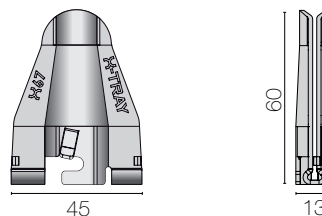



X67 X-Tray Divider Clamp

Pre-Galv	2267	1
Stainless 316L	2367	1



All dimensions in mm

ACCESSORIES

Article	Art.no.	Pack
X68 Earth Connection Clamp		
Brass	2568	1
Nickel coated. For up to 25 mm ² cables. For mounting of earth cable directly onto chosen wire in the X-Tray.		
 10  100		
More information on www.axelentwt.com		

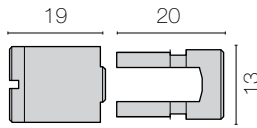

X60 Radius Limiter 120		
Zinc Plated	2160-120	1

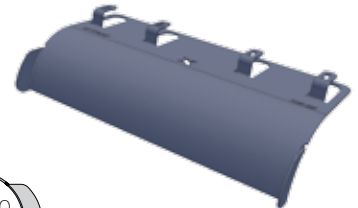
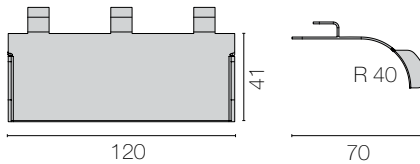

X60 Radius Limiter 220		
Zinc Plated	2160-220	1

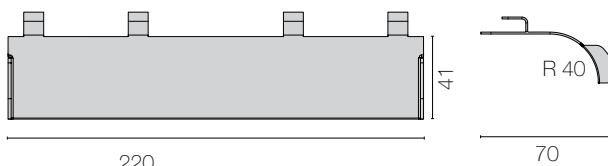

X60 Radius Limiter 320		
Zinc Plated	2160-320	1
Limits bend radius of sensitive cables. Can be combined for larger width.		
 8		

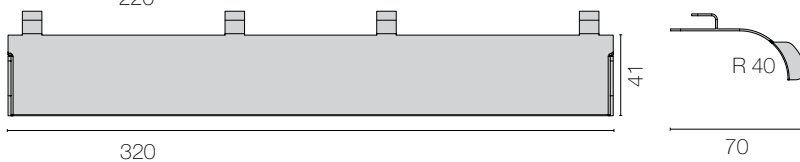

X65 X-Tray Cover 60		
Pre Galvanized	2265-60	1
Stainless 316L	2365-60	1

X65 X-Tray Cover 120		
Pre Galvanized	2265-120	1
Stainless 316L	2365-120	1

X65 X-Tray Cover 220		
Pre Galvanized	2265-220	1
Stainless 316L	2365-220	1

X65 X-Tray Cover 320		
Pre Galvanized	2265-320	1
Stainless 316L	2365-320	1

X65 X-Tray Cover 420		
Pre Galvanized	2265-420	1
Stainless 316L	2365-420	1

X65 X-Tray Cover 520		
Pre Galvanized	2265-520	1
Stainless 316L	2365-520	1

X65 X-Tray Cover 620		
Pre Galvanized	2265-620	1
Stainless 316L	2365-620	1

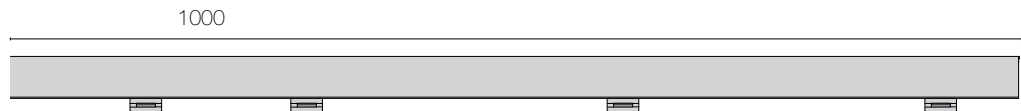

All dimensions in mm

ACCESSORIES

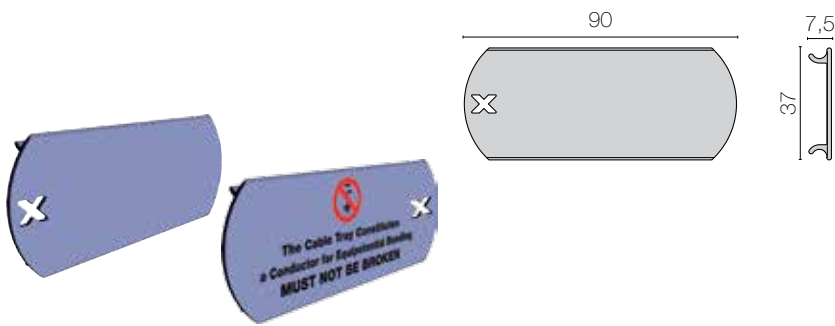

Article	Art.no.	Pack
X70 Marking Clip Neutral		
Plastic, white	2570-01	1
X70 Marking Clip Equipotential Bonding		
Swedish	2570-02	1
English	2570-03	1
German	2570-04	1
Plastic, halogen free.		

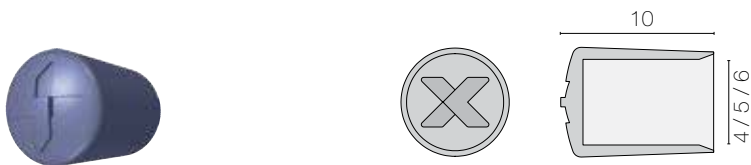

X72 Safety Cap, pack of 100		
Plastic, black Ø 4 mm	2572-4	1
Plastic, black Ø 5 mm	2572-5	1
Plastic, black Ø 6 mm	2572-6	1
Safety Cap for sharp edges. Halogen free.		



10

TOOLS

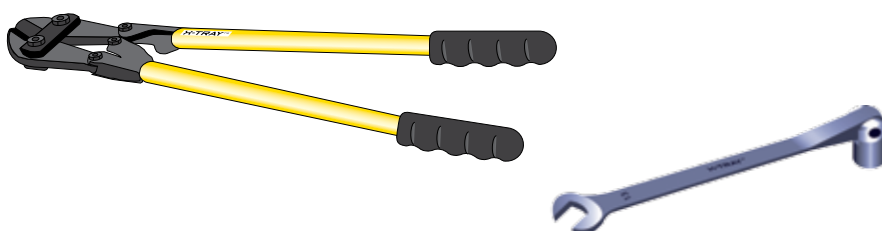

Article	Art.no.	Pack
X75 Bolt Cutter		
Chrome Molybden	2575	1
X76 Spanner 13 mm		
Chrome Vanadium	2576	1

THE AXELENT GROUP

The Axelent Group includes, in addition to Axelent Wire Tray AB, the following companies:



AXELENT AB

Axelent AB is a leading and rapidly growing company that produces and markets mesh panel systems for machine guarding and partitioning within industry, warehousing and property protection. The head office is in Hillerstorp, Sweden, along with a product development, production, storage and packaging. Axelent has sales offices in 50 countries and subsidiaries in Australia, Belgium, France, Germany, Italy, the Netherlands, Spain, the UK and the USA.

www.axelent.com



AXELENT ENGINEERING AB

Axelent Engineering AB provides services and products within automation predominantly to producing industry in Scandinavia. The core business is custom hardware and robotic solutions with an emphasis on profitable flow for the entire lifecycle. By partnering with Dassault Systèmes, a world leader in 3D and PLM (Product Lifecycle Management) solutions we can also offer PLM services and products such as CATIA, 3DVIA, DELMIA and ENOVIA. This combination makes Axelent Engineering an even more complete partner for the industry in terms of innovative and profitable flows.

www.axelentengineering.com

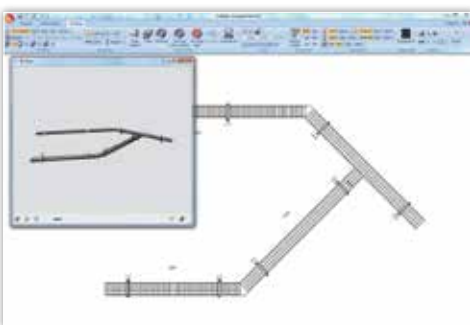

AXELENT SOFTWARE

Axelent Software develops and markets user licences for their in-house software applications SnapperWorks and SafetyWorks. The programs are based on distributed platforms and standards that ensure a long length of life, continuous development and easy connectivity to other systems. Axelent Software's products are based on simplicity and ease of use and is in its original version developed for Axelent's products, but through various customizations applicable in most industries with standardized products.

www.snapperworks.com



AXELENT SAFETY

Axelent AB also embraces the business area Axelent Safety, which offers complete machine safety solutions. Operations are divided into four sub areas. Risk Analysis, Design, Installation and Final Approval/CE Marking. Axelent Safety also provides training, consultancy and legal consultation within machine safety.

www.axelent.com

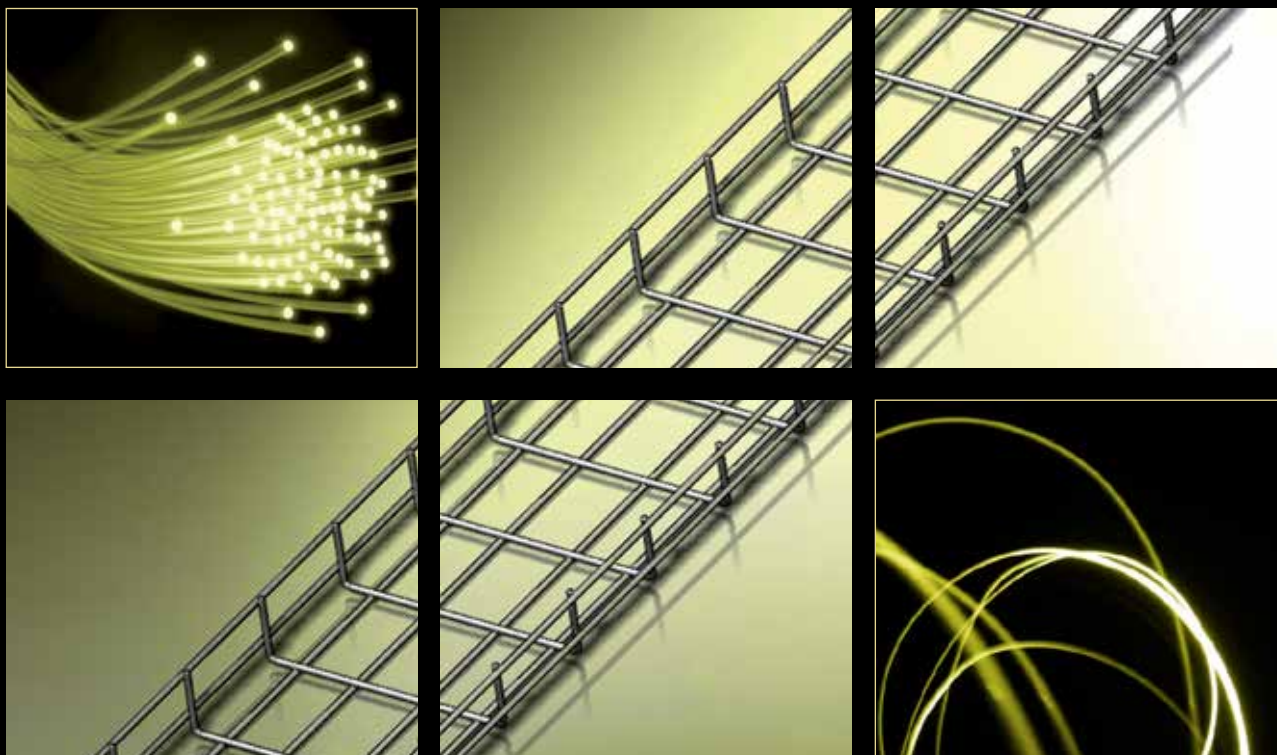

AXELENT WIRE TRAY AB

Axellent Wire Tray AB develops, manufactures and sells a cable channelling system based on wire trays, fittings, supports and accessories under the brand name X-Tray®. Axellent Wire Tray is a part of the Axellent Group, which also includes Axellent AB (market leader within the manufacture of mesh wall systems in the form of protection and partitioning systems for industry, warehouses and construction), Axellent Software (software) and Axellent Engineering AB (automation solutions). Axellent's head office is in Hillerstorp, Sweden, along with product development, production, storage and packaging. Axellent has sales offices in 50 countries and the products are sold over the world.

Haberkorn s.r.o.
Generála Vlachého 305
747 62 Mokré Lazce
Česká republika

Spojovatelka:
tel.: +420 553 757 111
fax: +420 553 757 101
info@haberkorn.cz
www.haberkorn.cz

Divize Oplocení:
tel.: +420 553 757 234
fax: +420 553 757 120
oploceni@haberkorn.cz
www.haberkorn.cz

HABERKORN

**Bezplatný kontakt pre
slovenských zákazníkov:**
tel.: 0800 042 204
fax: 0800 042 205
info@haberkorn.sk
www.haberkorn.sk